

Appendix A—Primary Containment for Biohazards: Selection, Installation, and Use of Biological Safety Cabinets

Part 1—Introduction

This document presents information on the design, selection, function, and use of Biological Safety Cabinets (BSCs), also referred to as biosafety cabinets, which are the primary means of containment for working safely with infectious microorganisms and prions. Brief descriptions of the facility and engineering concepts for the conduct of microbiological research are also provided. BSCs are only one part of an overall biosafety program, which requires consistent use of good microbiological practices, use of primary containment equipment, and proper containment facility design. Detailed descriptions of acceptable work practices, procedures, and facilities, known as Biosafety Levels (BSL) 1 to 4, are presented in [Section IV](#) of BMBL.

BSCs are designed to provide personnel and environmental protection when appropriate practices and procedures are followed. Three kinds of BSCs, designated as Class I, II and III, have been developed to meet varying research and clinical needs. Class II and Class III cabinets provide operator, product, and environmental protection. Most BSCs use High-Efficiency Particulate Air (HEPA) filters in the exhaust and supply systems. Ultra-Low Particulate Air (ULPA) filters are used for some special applications. The exception is a Class I BSC, which has HEPA-filtered exhaust air only.

This appendix is divided into seven Parts. HEPA and ULPA filters and their use in BSCs are briefly described in Part 2. Part 3 presents a general description of the special features of BSCs that provide varying degrees of personnel, environmental, and product protection. Laboratory hazards and risk assessment are discussed in Part 4. Part 5 presents work practices, procedures, and practical tips to maximize the protection afforded by the most commonly used BSCs. Facility and engineering requirements needed for the operation of each type of BSC are presented in Part 6. Part 7 reviews requirements for routine certification intervals to ensure proper operation and integrity of a Class II BSC.

These Parts are not meant to be definitive or all-encompassing. Rather, an overview is provided to clarify the expectations, functions, and performance of these critical primary barriers. This document has been written for the biosafety professionals, laboratorians, engineers, and managers who desire a better understanding of each type of cabinet; the factors considered for the selection of a BSC to meet specific operational needs; and the services required to maintain the operational integrity of the cabinet.

Proper maintenance of BSCs used for work at all Biosafety Levels cannot be overemphasized. Biosafety professionals and laboratorians need to understand that an active BSC is a primary containment device. A BSC must be routinely inspected and tested by trained personnel, following strict protocols, to verify that it is working properly. This process, referred to as certification of the BSC, should be performed at least annually, or as specified in Part 7 of this section.

Part 2—High-Efficiency Particulate Air (HEPA) Filters and the Development of Biological Containment Devices

Since the earliest Laboratory-associated infections (LAIs) with *S. Typhi* to the contemporary hazards posed by bioterrorism, antibiotic-resistant bacteria, and rapidly mutating viruses, threats to worker safety have stimulated the development and refinement of workstations where infectious microorganisms could be safely handled. These workstations have helped maintain sterility of cell lines, minimize cross-contamination, and maintain product integrity. The use of proper procedures and equipment, as described in [Section IV](#) of BMBL, cannot be overemphasized in providing primary personnel and environmental protection. For example, high-speed blenders designed to reduce aerosol generation, needle-locking syringes, micro burners, and safety centrifuge cups or sealed rotors are among the engineered devices that protect laboratory workers from biological hazards. An important piece of safety equipment is the BSC, in which manipulations of infectious microorganisms are performed.

Background

Early prototype clean air cubicles were designed to protect the materials being manipulated from environmental or worker-generated contamination rather than to protect the worker from the risks associated with the manipulation of potentially hazardous materials. Filtered air was blown across the work surface directly at the worker. Therefore, these cubicles could not be used for handling infectious agents because the worker was in a contaminated air stream.

To protect the worker during manipulations of infectious agents, a small workstation was needed that could be installed in existing laboratories with minimum modification to the room. The earliest designs for primary containment devices were essentially non-ventilated boxes built of wood, and later of stainless steel, in which simple operations such as weighing materials could be accomplished.¹

Early versions of ventilated cabinets did not have adequate or controlled directional air movement. They were characterized by mass airflow into the cabinets with widely varying air volumes across openings. Mass airflow into a cabinet drew contaminated air away from the laboratory worker. This was the forerunner of the Class I BSC. However, since the inflow air was unfiltered, the cabinet

was contaminated with environmental microorganisms and other undesirable particulate matter.

Control of airborne particulate materials became possible with the development of filters that efficiently removed microscopic contaminants from the air. The HEPA filter was developed to create dust-free work environments (e.g., cleanrooms and clean benches) in the 1940s.¹

HEPA and ULPA Filters HEPA filters used in most BSCs remove the Most Penetrating Particle Size (MPPS) of approximately 0.3 μm with a minimum efficiency of 99.99%, while ULPA filters remove particles of average size 0.1–0.2 μm or 0.2–0.3 μm with minimum efficiency of 99.999%.² Particles both larger and smaller than the MPPS (including bacterial spores and viruses) are removed with greater efficiency. HEPA and ULPA filter efficiency and the mechanics of particle collection by these filters are well-studied and well- documented; therefore, only a brief description is included here.^{3,4}

The typical HEPA filter medium is a single sheet of borosilicate fibers treated with a wet-strength, water-repellant binder. Advances in filtration science have also seen the introduction of HEPA and ULPA filters with different media types such as polytetrafluoroethylene (PTFE [i.e., Teflon]) for use in BSCs and similar devices. The filter medium is pleated to increase the overall surface area inside the filter frames and the pleats are often divided by corrugated aluminum separators (Figure 1). The separators prevent the pleats from collapsing in the air stream and provide a path for airflow. Alternate designs providing substitutions for the aluminum separators may also be used and are known as separatorless filters. The filter is glued into a wood, metal, or plastic frame. Careless handling of the filter (e.g., improper storage or dropping) can damage the medium at the glue joint and cause tears or shifting of the filter resulting in leaks in the medium. This is the primary reason why filter integrity must be tested when a BSC is installed initially and each time it is moved or relocated (Part 7).

Various types of containment and similar devices incorporate the use of HEPA and ULPA filters in the exhaust and/or supply air system to remove airborne particulate material. It should be noted that, although ULPA filters can be used in BSCs, there is not at this time a specific situation that requires them. ULPA filters are more expensive to purchase and can raise energy costs and be detrimental to the lifespan of the device motors due to the increased resistance through the filter. Depending on the configuration of these filters and the direction of the airflow, varying degrees of personnel, environmental, and product protection can be achieved.⁵ Part 5 describes the proper practices and procedures necessary to maximize the protection afforded by the various devices.

Part 3—Biological Safety Cabinets

The similarities and differences in protection offered by the various classes of BSCs are reflected in Table 1. Please also refer to Table 2 and Part 4 for further considerations pertinent to BSC selection and risk assessment.

The Class I BSC

The Class I BSC provides personnel and environmental protection but no product protection. It is similar in terms of air movement to a chemical fume hood but has a HEPA filter in the exhaust system to protect the environment (Figure 2). In the Class I BSC, unfiltered room air is drawn in through the work opening and across the work surface. Personnel and environmental protection is provided by a minimum inward airflow velocity of 75 linear feet per minute (lfm) through the front opening.⁶ Because product protection is provided by the Class II BSCs, general usage of the Class I BSC has declined. Class I BSCs are used where aerosols may be generated and product protection is not required, such as for cage dumping, culture aeration, or tissue homogenization, or to enclose equipment (e.g., centrifuges, harvesting equipment, or small fermenters).

The classical Class I BSC is direct-connected to the building exhaust system and the building exhaust fan provides the negative pressure necessary to draw room air into the cabinet. The airflow pattern into a Class I is similar to a chemical fume hood where unfiltered laboratory air flows inward over the product. Any aerosols and particulates are pulled into an exhaust plenum that contains a HEPA filter, which filters out the aerosols and particulates.

Some Class I BSCs are equipped with an integral exhaust fan. In this case, the cabinet air may be recirculated into the laboratory if no noxious or toxic gases or vapors are used. This Class I BSC may also be canopy connected with an exhaust alarm when hazardous gases or vapors are used.

A panel with openings to allow access for the hands and arms to the work surface can be added to the Class I cabinet. The restricted opening results in increased inward air velocity, increasing worker protection. For added safety, arm-length gloves can be attached to the panel. Makeup air is then drawn through an auxiliary air supply opening (which may contain a filter) and/or around a loose-fitting front panel.

Some Class I models used for animal cage changing are designed to allow recirculation of air into the room after HEPA filtration and may require more frequent filter replacement due to filter loading and odor from organic material captured on the filter.

All Class I BSCs should be certified annually for sufficient airflow and filter integrity.

The Class II BSC

As biomedical researchers began to use sterile animal tissue and cell culture systems, particularly for the propagation of viruses, cabinets were needed that also provided product protection. In the early 1960s, the *laminar flow* principle evolved. Unidirectional air moving at a fixed velocity along parallel lines was demonstrated to reduce turbulence resulting in predictable particle behavior. Biocontainment technology also incorporated this laminar or uniform, directional flow principle with the use of the HEPA filter to aid in the capture and removal of airborne contaminants from the air stream.⁷ This combination of technologies that exists in the Class II BSC serves to help protect the laboratory worker from potentially infectious aerosols⁴ generated within the cabinet and also provides necessary product protection. Class II BSCs are partial barrier systems that rely on the directional movement of air to provide containment. As the air curtain is disrupted (e.g., movement of materials in and out of a cabinet, rapid or sweeping movement of the arms) the potential for contaminant release into the laboratory work environment is increased, as is the risk of product contamination.

The Class II (Types A1, A2, B1, B2, and C1)⁸ BSCs provide personnel, environmental, and product protection. Airflow is drawn into the front grille of the cabinet, providing personnel protection. In addition, the downward flow of HEPA-filtered air provides product protection by minimizing the chance of cross-contamination across the work surface of the cabinet. Because cabinet exhaust air is passed through a certified HEPA filter, it is particulate-free (environmental protection), and may be recirculated to the laboratory (Type A1, A2, and C1 BSCs) or discharged from the building through a canopy (formerly thimble) connected to the building exhaust.

It is possible to exhaust the air from a Type A1, A2, or C1 cabinet outside of the building. When using volatile toxic chemicals, removal of the exhaust from the laboratory is required. However, it must be done in a manner that does not alter the balance of the cabinet exhaust system, thereby disturbing the internal cabinet airflow. The proper method of connecting a Type A1, A2, or C1 cabinet to the building exhaust system is through use of a canopy connection,^{8,9} which provides a small opening or air gap (usually one inch) around the cabinet exhaust filter housing (Figure 4). The airflow of the building exhaust must be sufficient to maintain the flow of room air into the gap between the canopy unit and the filter housing. The canopy must be removable or be designed to allow for operational testing of the cabinet and must have an alarm to indicate insufficient airflow through the canopy (Part 6). Class II, Type A1 or A2 cabinets should never be direct-connected to the building exhaust system.⁸ Fluctuations in air volume and pressure that are common to all building exhaust systems can make it difficult to match the airflow requirements of the cabinet.

Type B cabinets must be direct-connected, preferably to a dedicated, independent exhaust system. Fans for laboratory exhaust systems should be located at the terminal end of the ductwork to avoid pressurizing the exhaust ducts. A failure in the building exhaust system may not be apparent to the user, as the supply blowers in the cabinet will continue to operate. A pressure-independent monitor and alarm must be installed to provide a warning and shut off the BSC supply fan, should a failure in exhaust airflow occur. Since this feature is not supplied by all cabinet manufacturers, it is prudent to install a sensor such as a flow monitor and alarm in the exhaust system as necessary. To maintain critical operations, laboratories using Type B BSCs should connect the exhaust blower to the emergency power supply.

HEPA filters are effective at trapping particulates, and thus infectious agents, but do not capture volatile chemicals or gases. Only canopy-connected Type A1, A2, and C1 or Types B1 and B2 BSCs should be used when working with volatile, toxic chemicals, but amounts must be limited (Table 2).

The mechanical design and air balance testing of the laboratory exhaust system for Class IIB BSCs must use Concurrent Balance Values (CBV) as published in the NSF/ANSI 49 Standard—a standard that describes the requirements for the construction and function of a Class II BSC.⁸ When a BSC is certified to NSF/ANSI 49-2018, the standard method is to set the inflow velocities using a direct inflow measurement (DIM) hood. When the HVAC system air balance is set, it is typically done based on duct traverse air measurements taken at some point in the ductwork. The two groups are attempting to measure and set the BSC inflows, but each is using a different type of instrument and taking airflow measurements at different locations. There can be a difference in air volume measurements between the two. The CBV provides each discipline the information they require to properly test or certify the BSC.

All Class II cabinets are designed for work involving microorganisms assigned to Risk Groups (RG) 1–4. Class II BSCs provide the microbe-free work environment necessary for cell culture propagation and also may be used for the formulation of nonvolatile antineoplastic or chemotherapeutic drugs.^{10,11} Class II BSCs may be used with organisms requiring BSL-4 containment in a BSL-4 suit laboratory by a worker wearing a positive-pressure protective suit. Maximum containment potential is achieved only through strict adherence to proper practices and procedures.

Class II, Type A1 BSC An internal fan (Figure 3) draws sufficient room air through the front grille to maintain a minimum calculated or measured average inflow velocity of at least 75 lfm at the face opening of the cabinet. The supply air flows through a HEPA filter and provides particulate-free air to the work surface. Airflow provided in this manner reduces turbulence in the work zone and minimizes the potential for cross-contamination.

The downward moving air splits as it approaches the work surface; the fan draws part of the air to the front grille and the remainder to the rear grille. Although there are variations among different cabinets, this split generally occurs about halfway between the front and rear grilles and two to six inches above the work surface.

The air is drawn through the front and rear grilles by the internal fan and pushed into the space between the supply and exhaust filters. Due to the relative size of these two filters, approximately 30% of the air passes through the exhaust HEPA filter and 70% recirculates through the supply HEPA filter back into the work zone of the cabinet. Most Class II, Type A1, and A2 cabinets have dampers to modulate this division of airflow.

Since 2010, a Class II A1 cabinet may not have a potentially contaminated positively pressurized plenum that is not surrounded by a negatively pressurized plenum. This change has minimized the difference between an A1 and A2 cabinet to the inflow velocity.

Class II, Type A2 BSC (Formerly called A/B3) Only when this BSC (Figure 3) is ducted to the outdoors does it meet the requirements of the former Class II, Type B3.⁸ The designation Class II B3 is no longer used. The Type A2 cabinet has a minimum calculated or measured inflow velocity of 100 lfm. All positive-pressure contaminated plenums within the cabinet are surrounded by a negative air pressure plenum thus ensuring that any leakage from a contaminated plenum will be drawn into the cabinet and not released to the environment. Small quantities of volatile toxic chemicals or radionuclides can be used in a Type A2 cabinet only if it exhausts to the outside via a properly functioning canopy with exhaust alarm.⁸

Class II, Type B1 BSC Some biomedical research requires the use of small quantities of toxic volatile chemicals, such as organic solvents or carcinogens. Carcinogens used in cell culture or microbial systems require both biological and chemical containment.⁹

The Class II, Type B cabinet originated with the National Cancer Institute (NCI)-designed Type 212 (later called Type B) BSC (Figure 5a) and was designed for manipulations of small quantities of toxic volatile chemicals with *in vitro* biological systems. The NSF/ANSI 49-2018 definition of Type B1 cabinets⁸ includes this classic NCI design Type B; cabinets without a supply HEPA filter located immediately below the work surface (Figure 5b); and those with exhaust/recirculation downflow ratios other than 70/30%.

The cabinet supply blower draws room air (plus a portion of the cabinet's recirculated air) through the front grille and through the supply HEPA filter located immediately below the work surface. This particulate-free air flows upward through a plenum at each side of the cabinet and then downward to the work area through

a backpressure plate. In some cabinets, there is an additional supply HEPA filter to remove particulates that may be generated by the blower-motor system.

Room air is drawn through the face opening of the cabinet at a minimum measured inflow velocity of 100 lfm. As with the Type A1 and A2 cabinets, there is a split in the down-flowing air stream just above the work surface. In the Type B1 cabinet, approximately 70% of the downflow air exits through the rear grille, passes through the exhaust HEPA filter, and is discharged from the building. The remaining 30% of the downflow air is drawn through the front grille. Since the air that flows to the rear grille is discharged into the exhaust system, activities that may generate toxic volatile chemical vapors or gases should be conducted toward the rear of the cabinet work area.¹²

Class II, Type B2 BSC This BSC is a total-exhaust cabinet; no air is recirculated within it (Figure 6). This cabinet provides simultaneous primary biological and chemical (small quantity) containment. Consideration must be given to the chemicals used in BSCs as some chemicals can destroy the filter medium, housings, and/or gaskets causing loss of containment. The supply blower draws either room or outside air in at the top of the cabinet, passes it through a HEPA filter and down into the work area of the cabinet. The building exhaust system draws air through both the rear and front grilles, capturing the supply air plus the additional amount of room air needed to produce a minimum calculated or measured inflow face velocity of 100 lfm. All air entering this cabinet is exhausted and passes through a HEPA filter (and perhaps some other air-cleaning device, such as a carbon filter, if required, for the work being performed prior to discharge to the outside). This cabinet exhausts as much as 1,200 cubic feet per minute of conditioned room air making this cabinet expensive to operate. The higher static air pressure required to operate this cabinet also results in additional costs associated with heavier gauge ductwork and higher capacity exhaust fan. Therefore, the need for a Class II, Type B2 should be justified by the risk assessment of the research to be conducted.

Should the building exhaust system fail, the cabinet will be pressurized, resulting in a flow of air from the work area back into the laboratory.

Cabinets built since the early 1980s have an interlock system, installed by the manufacturer, to prevent the supply blower from operating whenever the exhaust flow is insufficient; systems can be retrofitted. Exhaust air movement should be monitored by a pressure-independent device, such as a flow monitor.

Class II, Type C1 BSC This BSC is similar to a Type B1 BSC in that it has a special region of the work area intended for work with toxic volatile chemicals that are exhausted from the building (Figure 7a). However, it also has an internal exhaust blower that allows the BSC to be either room recirculated if no volatile toxic chemicals or vapors are present or canopy-connected with an exhaust alarm

if volatile toxic chemicals are used. Room air is drawn through the face opening of the cabinet at a minimum measured inflow velocity of 100 fpm. The down-flowing air stream just above the work surface is split by a specific grille pattern with a portion of 70% to be exhausted and the remaining 30% recirculated. If the air that flows over the specific region is discharged into the exhaust system, activities that may generate toxic, volatile chemicals or gases must only be conducted in that area of the cabinet work zone if connected to a properly functioning canopy with alarm (Figure 7b). If canopy connected during a building system failure, the BSC must be either interlocked with the cabinet blower(s) alarm to shut off the cabinet or, if using a sealed and tested duct system and if permitted by a chemical risk assessment, may continue to operate for up to five minutes pressurizing the duct and indicating the time remaining before the BSC is shut off.

Special Applications Class II BSCs can be modified to accommodate special tasks. For example, the front sash can be modified by the manufacturer to accommodate the eyepieces of a microscope. The work surface can be designed to accept a carboy, a centrifuge, or other equipment that may require containment. A rigid plate with openings for the arms can be added if needed. Good cabinet design, microbiological aerosol tracer testing of the modification, and appropriate certification (Part 7) are required to ensure that the basic systems operate properly after modification (Part 5).

The Class III BSC

The Class III BSC (Figure 8) was designed for work with highly infectious microbiological agents and the conduct of hazardous operations and provides maximum protection for the environment and the worker. It is a gas-tight (no leak greater than 1×10^{-7} cc/sec with 1% test gas at three inches pressure water gauge¹³) enclosure with a non-opening view window. Access for passage of materials into the cabinet is through a dunk tank that is accessible through the cabinet floor or a double-door pass-through box (e.g., antechamber, autoclave) that can be decontaminated between uses. Reversing that process allows materials to be removed from the Class III BSC safely. Both supply and exhaust air are HEPA-filtered on a Class III cabinet. Exhaust air must pass through two HEPA filters, or a HEPA filter and an air incinerator, before discharge directly to the outdoors. Class III cabinets are not exhausted through the general laboratory exhaust system. Using a dedicated exhaust system reduces the risk of outside ventilation influences on Class III containment performance. Airflow is maintained by an exhaust system exterior to the cabinet, which keeps the cabinet under negative pressure (minimum of 0.5 in water gauge). This level of negative pressure is required to minimize risk and maintain containment if a breach occurs such as holes or tears in the glove system.

Long, heavy-duty rubber gloves are attached in a gas-tight manner to ports in the cabinet to allow direct manipulation of the materials isolated inside. Although

these gloves restrict movement, they prevent the user's direct contact with the hazardous materials. The trade-off is clearly on the side of maximizing personal safety. Depending on the design of the cabinet, the supply HEPA filter provides particulate-free, albeit somewhat turbulent, airflow within the work environment. Laminar or uniform airflow is optional but not a typical characteristic of a Class III cabinet.

Several Class III BSCs can be joined together in series to provide a larger work area. Such cabinet lines are custom-built; the equipment installed in the cabinet series (e.g., refrigerators, small elevators, shelves to hold small animal cage racks, microscopes, centrifuges, incubators) is generally custom-built as well.

Horizontal Laminar Flow Clean Bench Horizontal laminar flow clean benches (also referred to as clean air devices [CADs]) are not BSCs (Figure 9a). These pieces of equipment discharge HEPA-filtered air from the back of the cabinet across the work surface and toward the user. These devices only provide product protection. They can be used for certain clean activities, such as the dust-free assembly of sterile equipment or electronic devices. Clean benches should never be used when handling cell culture materials, drug formulations, potentially infectious materials, or any other potentially hazardous materials. The worker will be exposed to the materials being manipulated on the clean bench potentially resulting in hypersensitivity, toxicity, or infection depending on the materials being handled. Horizontal airflow clean benches must never be used as a substitute for a biological safety cabinet. Users must be aware of the differences between these two devices.

Vertical Flow Clean Bench Vertical flow clean benches or CADs (Figure 9b) also are not BSCs. They may be useful, for example, in hospital pharmacies when a clean area is needed for preparation of intravenous solutions or for the preparation of nucleic acids for PCR. While these units generally have a sash, the air is usually discharged into the room under the sash, resulting in the same potential worker exposure issues presented by the horizontal laminar flow clean benches. These benches should never be used when handling cell culture materials, drug formulations, potentially infectious materials, or any other potentially hazardous materials.

Part 4—Other Laboratory Hazards and Risk Assessment

Primary containment is an important strategy in minimizing exposure to the many chemical, radiological and biological hazards encountered in the laboratory. In Table 2, an overview is provided of the various classes of BSCs, the level of containment afforded by each, and the appropriate risk assessment considerations. Microbiological risk assessment is addressed in depth in [Section II](#) of BMBL.

Working with Chemicals in BSCs

Work with infectious microorganisms often requires the use of various chemical agents, and many commonly used chemicals vaporize easily. Therefore, evaluation of the inherent hazards of the chemicals must be part of the risk assessment when selecting a BSC. Flammable chemicals should not be used in Class II, Type A1, A2, and non-ducted Type C1 cabinets since vapor buildup inside the cabinet presents a fire hazard. In order to determine the greatest chemical concentration that might be entrained in the air stream following an accident or spill, it is necessary to evaluate the quantities to be used. Mathematical models are available to assist in these determinations.¹² For more information regarding the risks associated with exposure to chemicals, the reader should consult the Permissible Exposure Levels determined under OSHA regulations available at <https://www.osha.gov/dsg/annotated-pels/tablez-1.html> and Threshold Limit Values (TLVs) for various chemical substances established by the American Conference of Governmental Industrial Hygienists.¹⁴

The electrical systems of Class II BSCs are not spark-proof. Therefore, a chemical concentration approaching the lower explosive limits of the compound must be prohibited. Furthermore, since non-exhausted Class II, Type A1, A2, and C1 cabinets return chemical vapors to the cabinet workspace and the room, they may expose the operator and other room occupants to toxic chemical vapors.

A chemical fume hood should be used for procedures using volatile chemicals instead of a BSC when biological containment is not needed. Chemical fume hoods are connected to an independent exhaust system and operate with single-pass air discharged, directly or through a manifold, outside the building. They may also be used when manipulating chemical carcinogens.⁹ When manipulating small quantities of volatile, toxic chemicals, required for use in microbiological studies, Class I and Class II (Type B1 and B2) BSCs, exhausted to the outdoors, can be used. The Class II, Type A1, A2, and C1 canopy-exhausted cabinets may be used with small quantities of volatile, toxic chemicals.⁸

Many liquid chemicals, including nonvolatile antineoplastic agents, chemotherapeutic drugs and low-level radionuclides, can be safely handled inside properly canopy connected Class II, Type A, and C1 cabinets.^{10,11} Class II BSCs should not be used for labeling of biohazardous materials with radioactive iodine or other volatile radionuclides. Hard-ducted, ventilated containment devices incorporating both HEPA and charcoal filters in the exhaust systems are necessary for the conduct of this type of work.

Many virology and cell culture laboratories use diluted preparations of chemical carcinogens^{15,16} and other toxic substances. Prior to maintenance, a careful evaluation must be made of potential problems associated with decontaminating the cabinet and the exhaust system. Air treatment systems, such as a charcoal filter¹⁶

may be required so that discharged air meets applicable emission regulations. A bag-in/bag-out housing may be needed to reduce the exposure risk to workers replacing chemically contaminated filters.

Radiological Hazards in the BSC

As indicated above, volatile radionuclides such as I^{125} should not be used within Class II BSCs. When using nonvolatile radionuclides inside a BSC, the same hazards exist as if working with radioactive materials on the benchtop. Work with nonvolatile radionuclides that has the potential for splatter or creation of aerosols can be done within the BSC.

Radiologic monitoring must be performed. A straight, vertical (i.e., not sloping) beta shield may be used inside the BSC to provide worker protection. A sloping shield can disrupt the air curtain and increase the possibility of contaminated air being released from the cabinet. A radiation safety professional should be contacted for specific guidance.

Risk Assessment

The potential for adverse events must be evaluated to eliminate, or reduce to the greatest extent possible, worker exposure to infectious organisms and to prevent release to the environment. Agent summary statements, detailed in [Section VIII](#) of BMBL or from other reputable sources, such as the Public Health Agency of Canada, provide data for microorganisms known to have caused Laboratory-associated infections that may be used in protocol-driven risk assessments. Through the process of risk assessment, the laboratory environment and the work to be conducted are evaluated to identify hazards and develop interventions to reduce risks to an acceptable level.

A properly certified and operational BSC is an effective engineering control (Part 6) that must be used in concert with the appropriate practices, procedures, and other administrative controls to further reduce the risk of exposure to potentially infectious microorganisms. Suggested work practices and procedures for minimizing risks when working in a BSC are detailed in Part 5.

Part 5—BSC Use by the Investigator: Work Practices and Procedures

Preparing for Work within a Class II BSC

Preparing a written checklist of materials necessary for a particular activity and placing necessary materials in the BSC before beginning work serves to minimize the number and extent of air curtain disruptions compromising the fragile air barrier of the cabinet. The rapid movement of a worker's arms in a sweeping motion into and out of the cabinet will disrupt the air curtain and compromise the partial containment barrier provided by the BSC. Moving arms in and out slowly, perpendicular to the face opening of the cabinet will reduce

this risk. Other personnel activities in the room (e.g., rapid movements near the face of the cabinet, walking traffic, room fans, open/closing room doors) may also disrupt the cabinet air barrier.⁶

Laboratory coats, preferably with knit or elastic cuffs, should be worn buttoned over street clothing; latex, vinyl, nitrile, or other suitable gloves are worn to provide hand protection. Increasing levels of PPE may be warranted as determined by an individual risk assessment. For example, a solid-front, back-closing laboratory gown provides better protection of personal clothing than a traditional laboratory coat and is a recommended practice at BSL-3.

Before beginning work, the investigator should adjust the stool height in an ergonomic position with proper back and feet support so that his/her face is above the front opening. Manipulation of materials should be delayed for approximately one minute after placing the hands/arms inside the cabinet. This allows the cabinet to stabilize, to *air sweep* the hands and arms, and to allow time for turbulence reduction. When the user's arms rest flatly across the front grille, occluding the grille opening, room air laden with particles may flow directly into the work area, rather than being drawn down through the front grille. Raising the arms slightly will alleviate this problem. Ergonomic elbow rests can also be used that elevate the elbows above the front grille so as to not disrupt the airflow and keep the user's arms and shoulders in a comfortable position. The front grille must not be blocked with such things as toweling, research notes, discarded plastic wrappers, and/or pipetting devices. All operations should be performed on the work surface at least four inches in from the front grille. If there is a drain valve under the work surface, it should be closed prior to beginning work in the BSC.

Materials or equipment placed inside the cabinet may cause disruption of the airflow, resulting in turbulence, possible cross-contamination, and/or breach of containment. Extra supplies (e.g., additional gloves, culture plates or flasks, culture media) should be stored outside the cabinet. Only the materials and equipment required for the immediate work should be placed in the BSC.

For some laboratory applications, specially designed BSCs containing large pieces of specialized equipment such as cell analyzers, flow cytometers, incubators, and centrifuges may be installed by the manufacturer and will require field certification. In those instances, the manufacturer should supply to the user the certification testing methodology information that assures the BSC will pass containment to NSF/ANSI 49-2018. In situations where a user places a new or different piece of equipment in the BSC, whether it is a special BSC or standard model, smoke visualization with equipment operational is required to field verify containment performance. The certifier should consult with the manufacturer during smoke visualization testing to provide guidance for the certification evaluation.

BSCs are performance verified by the manufacturer for use by a single individual at any given time. If it is deemed necessary by a facility for more than one person to be working in a BSC at the same time it should only be done after performing a comprehensive risk assessment for both product and personnel that encompasses hazard identification, exposure assessment, dose-response assessment, risk characterization, and a risk mitigation strategy.

BSCs are designed for 24-hour per day operation and some investigators believe that continuous operation of non-canopied Class IIA BSCs helps control the laboratory's level of dust and other airborne particulates. Although energy conservation may suggest BSC operation only when needed, especially if the cabinet is not used routinely, room air balance is an overriding consideration. Air discharged through ducted BSCs must be considered in the overall air balance of the laboratory. If night setback modes are used for BSC's, they must be interlocked to the laboratory supply and exhaust system to maintain negative laboratory air balance.

If the cabinet has been shut down, the blowers should be operated at least five minutes before beginning work to allow the cabinet to purge. This purge will remove any suspended particulates in the cabinet. The work surface, the interior walls (except the supply filter diffuser), and the interior surface of the window should be wiped with 70% ethanol (EtOH), a 1:100 dilution of household bleach (i.e., 0.05% sodium hypochlorite), or other disinfectant as determined by the investigator to meet the requirements of the particular activity. When bleach is used, a second wiping with sterile water is needed to remove the residual chlorine, which may eventually corrode stainless steel surfaces. Wiping with non-sterile water may recontaminate cabinet surfaces, which is a critical issue when sterility is essential (e.g., maintenance of cell cultures).

Similarly, the surfaces of all materials and containers placed into the cabinet should be wiped with 70% EtOH or other disinfectant determined to meet the laboratory's need to reduce the introduction of contaminants to the cabinet environment. This simple step will reduce introduction of mold spores and thereby minimize contamination of cultures. Further reduction of microbial load on materials to be placed or used in BSCs may be achieved by periodic decontamination of incubators and refrigerators.

Material Placement inside the BSC

Plastic-backed, absorbent toweling can be placed on the work surface but not on the front or rear grille openings. The use of toweling facilitates routine cleanup and reduces splatter and aerosol generation¹⁷ during an overt spill. It can be folded and placed in a biohazard bag or other appropriate waste receptacle when work is completed.

All materials should be placed as far back in the cabinet as practical, toward the rear edge of the work surface and away from the front and back grille of the cabinet. Similarly, aerosol-generating equipment (e.g., vortex mixers, tabletop centrifuges) should be placed toward the rear of the cabinet to take advantage of the air split described in Part 3. Bulky items such as biohazard bags, discard pipette trays, and vacuum collection flasks should be placed to one side of the interior of the cabinet. If placing those items in the cabinet requires opening the sash, make sure that the sash is returned to its original position before work is initiated. The correct sash position should be indicated on the front of the cabinet. An audible alarm will sound if the sash is in the wrong position while the fan is operating. Biological material or other hazardous agents should be placed in the BSC last.

Certain common practices interfere with the operation of the BSC. The biohazard collection bag should not be taped to the outside of the cabinet. This practice encourages the BSC user to frequently move in and out of the BSC to move discarded materials into the outside bag. Movement in and out of the BSC should be minimized to reduce the risk of biohazardous materials being brought out of the BSC or room contamination being brought into the BSC. Upright pipette collection containers should neither be used in BSCs nor placed on the floor outside the cabinet. The frequent inward/outward movement needed to place objects in these containers is disruptive to the integrity of the cabinet air barrier and can compromise both personnel and product protection. Horizontal pipette discard trays, which may contain an appropriate chemical disinfectant, should be used within the cabinet. Large sharps containers will interfere with the downward airflow and should not be used. Furthermore, potentially contaminated materials should not be brought out of the cabinet until they have been surface decontaminated or placed into a closable waste container for transfer to an incubator, autoclave, or another part of the laboratory. The closable waste container should also be surface decontaminated prior to removal.

Operations within a Class II BSC

Laboratory Hazards Many procedures conducted in BSCs may create splatter or aerosols. Good microbiological techniques should always be used when working in a BSC. For example, techniques used to reduce splatter and aerosol generation will also minimize the potential for personnel exposure to infectious materials manipulated within the cabinet. Class II cabinets are designed so that horizontally nebulized spores introduced into the cabinet will be captured by the downward flowing cabinet air within 14 in⁸ of travel. Therefore, keeping clean materials at least one foot away from aerosol-generating activities will minimize the potential for cross-contamination.

The workflow should be from clean to dirty (Figure 10). Materials and supplies should be placed in the cabinet in such a way as to limit the movement of dirty items over clean ones.

Several measures can be taken to reduce the chance for cross-contamination of materials when working in a BSC. Opened tubes or bottles should not be held in a vertical position. Investigators working with Petri dishes and tissue culture plates should hold the lid above the open sterile surface to minimize direct impaction of downward air. Bottle or tube caps should not be placed on the towelings if used. Items should be recapped or covered as soon as possible.

Open flames are neither required nor recommended in the near microbe-free environment of a biological safety cabinet. On an open bench, flaming the neck of a culture vessel will create an upward air current that prevents microorganisms from falling into the tube or flask. An open flame in a BSC, however, creates turbulence that disrupts the pattern of HEPA-filtered air being supplied to the work surface. When deemed absolutely necessary and approved by the appropriate facility authorities after a thorough risk assessment, touch-plate micro burners equipped with a pilot light to provide a flame on demand may be used. Internal cabinet air disturbance and heat buildup will be minimized. The burner must be turned off when work is completed. Small electric furnaces are available for decontaminating bacteriological loops and needles and are preferable to an open flame inside the BSC. Disposable loops should be used whenever possible.

Aspirator bottles or suction flasks should be connected to an overflow collection flask containing appropriate disinfectant and to an in-line HEPA or equivalent filter (Figure 11). Commercial equivalents are acceptable once validated for specific laboratory use. This combination will provide protection to the central building vacuum system or vacuum pump, as well as to the personnel who service this equipment. Inactivation of aspirated materials can be accomplished by placing a volume of a chemical decontamination solution having a concentration of chemical sufficient to decontaminate microorganisms when the flask is filled to its maximum capacity into the flask to inactivate the microorganisms as they are collected. Once inactivation occurs, liquid materials can be disposed of as noninfectious waste. The flask material should be resistant to the decontamination solution used.

Investigators must determine the appropriate method of decontaminating wastes that will be removed from the BSC at the conclusion of the work. When chemical means alone are appropriate, a suitable liquid disinfectant should be placed into a discard pan before work begins. Items should be introduced into the pan with minimum splatter, covered completely, and allowed appropriate contact time as per manufacturer's instructions. Alternatively, liquids can be autoclaved prior to disposal. The liquid container should be placed in a suitable, secondary container,

and the outside of these containers wiped with a suitable liquid disinfectant, prior to removal from the BSC.

When a steam autoclave is used for solid wastes, contaminated materials should be placed into a biohazard bag or discard pan. Adding water to ensure steam generation during the autoclave cycle needs to be determined experimentally. The bag should be loosely closed (to allow steam to enter the bag) or the discard pan should be covered in the BSC prior to transfer to the autoclave. The bag should be transported and autoclaved in a leak-proof tray or pan. It is a prudent practice to decontaminate the exterior surface of bags and pans just prior to removal from the cabinet.

Decontamination

Cabinet Surface Decontamination With the cabinet blower running, all containers and equipment should be surface decontaminated and removed from the cabinet when work is completed. All biological materials and hazardous agents should be removed first. At the end of the workday, the final surface decontamination of the cabinet should include a wipe-down of the work surface, the cabinet's sides and back, and the interior of the glass. If necessary, the cabinet should also be monitored for radioactivity and decontaminated when necessary. Investigators should remove their gloves and gowns in a manner to prevent contamination of unprotected skin and aerosol generation and wash their hands as the final step in safe microbiological practices. The cabinet blower may be left on or turned off after these operations are completed.

Small spills within the operating BSC can be handled immediately by removing the contaminated absorbent paper toweling and placing it into the biohazard bag or receptacle. Small spills inside the BSC can be covered with paper towels, and starting from the outside of the spill, covered in an appropriate disinfectant. Once appropriate contact time is reached, usually 20 to 30 minutes, towels should be pushed from the edge of the spill to the center and disposed of into a biohazard bag or receptacle. Cabinet interior and items inside the BSC should be wiped down with a towel dampened with disinfectant. Gloves should be changed after the work surface is decontaminated and before placing clean absorbent toweling, if used in the cabinet.

Spills large enough to result in liquids flowing through the front or rear grilles require decontamination that is more extensive. All items within the cabinet should be surface decontaminated and removed. After ensuring that the drain valve is closed, decontaminating solution can be poured onto the work surface and through the grille(s) into the drain pan. The drain pan should be emptied into a collection vessel containing disinfectant. A hose barb and flexible tube should be attached to the drain valve and be of sufficient length to allow the open end to be submerged in the disinfectant within the collection vessel. This procedure

serves to minimize aerosol generation. The drain pan should be flushed with water, the drain tube removed, and the drain valve closed.

Should the spilled liquid contain a hazardous chemical or radioactive material, a similar procedure can be followed. The appropriate safety personnel should be contacted for specific instructions.

Periodic removal of the cabinet work surface and/or grilles after the completion of drain pan decontamination is recommended because of dirty drain pan surfaces and grilles, which ultimately could occlude the drain valve or block airflow. However, extreme caution should be observed while wiping these surfaces to avoid injury from sharp metal edges and other items (e.g., broken glass, pipette tips) that may be present. Always use disposable paper toweling and avoid applying harsh force. Wipe dirty surfaces gently. Never leave toweling on the drain pan because the paper could block the drain valve or the air passages in the cabinet.

Gas Decontamination BSCs that have been used for work involving infectious materials must be decontaminated before HEPA filters are changed or internal repair work is done.^{8,18–20} Before a BSC is relocated, a risk assessment considering the agents manipulated within the BSC must be performed to determine the need and method for decontamination. The most common decontamination methods use formaldehyde gas, hydrogen peroxide vapor,⁸ or chlorine dioxide gas.

Part 6—Facility and Engineering Requirements

Secondary Barriers

BSCs are considered the primary containment barrier for manipulation of infectious materials, and the laboratory room itself is considered the secondary containment barrier.²¹ Inward directional airflow is established by²² exhausting a greater volume of air than is supplied to a given laboratory and by drawing makeup air from the adjacent space. This is optional at BSL-2 but must be maintained at BSL-3 and BSL-4.²³ The air balance for the entire facility should be established and maintained to ensure that airflow is from areas of least to greater potential contamination.

Building Exhaust BSL-4 laboratory air must be directly exhausted to the outside since it is considered potentially contaminated. This concept is referred to as a dedicated, single-pass exhaust system. The exhausted room air can be HEPA-filtered when a high level of aerosol containment is needed, which is always true at BSL-4, but is an enhancement at BSL-3 and recommended for work with some organisms.³ When the building exhaust system is used to vent a Class IIB BSC, the exhaust system must be designed using the CBV and have sufficient capacity to maintain the exhaust flow if changes in the static pressure within the system should occur.⁸ The connection to a BSC must be constant air volume (CAV).

The HVAC exhaust system must be sized to handle both the room exhaust and the exhaust requirements of all containment devices that may be present. Adequate supply air must be provided to ensure appropriate function of the exhaust system. Right-angle bends, changing duct diameters, and transitional connections within the systems will add to the demand on the exhaust fan. The building exhaust air should be discharged away from supply air intakes, to prevent re-entrainment of laboratory exhaust air into the building air supply system. Refer to recognized design guides for locating the exhaust terminus relative to nearby air intakes.²⁴

Utility Services Utility services needed within a BSC must be planned carefully. Protection of vacuum systems must be addressed (Figure 11). Electrical outlets inside the cabinet must be protected by ground fault circuit interrupters and should be supplied by an independent circuit. The use of open flames in the BSC is not recommended.⁸ In very rare instances, when propane or natural gas needs to be provided, a clearly marked emergency gas shut-off valve outside the cabinet must be installed for fire safety. All non-electrical utility services should have exposed, accessible shut-off valves. The use of compressed air within a BSC must be carefully considered and controlled to prevent aerosol production and reduce the potential for vessel pressurization.

Ultraviolet Lamps Ultraviolet (UV) lamps should not be used as the sole disinfection method in a BSC. If installed, UV lamps should be cleaned regularly to remove any film that may block the output of the lamp. The lamps should be evaluated regularly and checked with a UV meter to ensure that the appropriate intensity of UV light is being emitted. Replace the bulb when the fluence rate is below 40 uW/cm². Unshielded UV lamps must be turned off when the room is occupied to protect eyes and skin from UV exposure. If the cabinet has a sliding sash, close the sash when operating the UV lamp. Most new BSCs use sliding sashes that are interlocked when operating the UV lamp to prevent exposure.

BSC Placement BSCs were developed as workstations to provide personnel, environmental, and product protection during the manipulation of infectious microorganisms. Certain considerations must be met to ensure maximum effectiveness of these primary barriers. Whenever possible, adequate clearance should be provided behind and on each side of the cabinet to allow easy access for maintenance and to ensure that the cabinet air re-circulated to the laboratory is not hindered. A 12–14 inch clearance above the cabinet is required to provide for accurate air velocity measurement across the exhaust filter surface^{25,26} and for exhaust filter changes. When the BSC is hard-ducted (direct-connected) or canopy connected to the ventilation system, adequate space must be provided so that the configuration of the ductwork will not interfere with airflow. The canopy unit must provide adequate access to the exhaust HEPA filter for testing.

The ideal location for the biological safety cabinet is remote from the entry (i.e., the rear of the laboratory away from traffic) since people walking parallel to the face of a BSC can disrupt the air curtain.^{8,16,27} The air curtain created at the front of the cabinet is quite fragile, amounting to a nominal inward and downward velocity of one mph. Open windows, air supply registers, portable fans, or laboratory equipment that creates air movement (e.g., centrifuges, vacuum pumps) should not be located near the BSC. Similarly, chemical fume hoods must not be located close to BSCs.

HEPA Filters HEPA filters, whether part of a building exhaust system or part of a cabinet, will require replacement when they become loaded to the extent that sufficient airflow can no longer be maintained. In most instances, filters must be decontaminated before removal. To contain the decontamination gas or vapor used for microbiological decontamination, exhaust systems containing HEPA filters require airtight dampers to be installed on both the inlet and discharge side of the filter housing. This ensures containment of the gas or vapor inside the filter housing during decontamination. Access panel ports in the filter housing also allow for performance testing of the HEPA filter (Part 7).

A bag-in/bag-out filter assembly^{3,28} (Figure 12) can be used in situations where HEPA filtration is necessary for operations involving biohazardous materials and hazardous or toxic chemicals. The bag-in/bag-out system is used when it is not possible to gas or vapor decontaminate the HEPA filters, or when hazardous chemicals or radionuclides have been used in the BSC, and provides protection against exposure for the maintenance personnel and the environment. A bag-in/bag-out system will require a method to decontaminate or safely dispose of the filter once removed (e.g., a waste service that will decontaminate the filter, or a large enough autoclave). Note, however, that this requirement must be identified at the time of purchase and installation; a bag-in/bag-out assembly cannot be added to a cabinet after-the-fact without an extensive engineering evaluation.

Part 7—Certification of BSCs

Development of Containment Standards

The evolution of containment equipment for varied research and diagnostic applications created the need for consistency in construction and performance. Federal Standard 209²⁹ was developed to establish classes of air cleanliness and methods for monitoring clean workstations and cleanrooms where HEPA filters are used to control airborne particulates. It has since been replaced with ISO 14644-2015.³⁰

The first “standard” to be developed specifically for BSCs¹² served as a Federal procurement specification for the NIH Class II, Type 1 (now called Type A1) BSC, which had a fixed or hinged front window or a vertical sliding sash, vertical downward airflow, and HEPA-filtered supply and exhaust air. This specification

described design criteria and defined prototype tests for microbiological aerosol challenge, velocity profiles, and leak testing of the HEPA filters. A similar procurement specification was generated³¹ when the Class II, Type 2 (now called Type B1) BSC was developed.

NSF/ANSI 49 for Class II BSCs was first published in 1976, providing the first independent standard for design, manufacture, and testing of BSCs. This standard replaced the NIH specifications, which were being used by other institutions and organizations purchasing BSCs. NSF/ANSI 49-2018⁸ incorporates current specifications regarding design, construction, performance, and field certification. This Standard for BSCs establishes performance criteria and provides the minimum testing requirements that are accepted in the United States. Cabinets that meet the Standard and are certified by NSF bear an “NSF” mark.

NSF/ANSI 49-2018 pertains to all models of Class II cabinets (Type A1, A2, B1, B2, C1) and provides a series of specifications regarding:

- Design/construction;
- Performance;
- Installation recommendations; and
- Recommended microbiological decontamination procedures.

References and specifications pertinent to Class II Biosafety Cabinetry, Annex F of NSF/ANSI 49-2018, which covers field testing of BSCs, is a normative part of the Standard. This Standard is reviewed periodically by a committee of experts to ensure that it remains consistent with developing technologies

The operational integrity of a BSC must be validated before it is placed into service and after it has been repaired or relocated. Relocation may break the HEPA filter seals or otherwise damage the filters or the cabinet. Each BSC should be tested and certified at least annually to ensure continued, proper operation.

On-site field certification (NSF/ANSI 49-2018, Annex F) must be performed by experienced, qualified personnel. Some basic information is included in the Standard to assist in understanding the frequency and kinds of tests to be performed. In 1993, NSF began a program for accreditation of certifiers based on written and practical examinations. Education and training programs for persons seeking accreditation as qualified to perform all field certification tests are offered by a variety of organizations. Selecting competent individuals to perform testing and certification is important. It is suggested that the institutional biosafety officer (BSO) or Health and Safety Office be consulted when identifying companies qualified to conduct the necessary field performance tests.

It is strongly recommended that, whenever possible, accredited field certifiers are used to test and certify BSCs. If in-house personnel are performing the certifications, then these individuals should become accredited.

Performance Testing BSCs in the Field

Class II BSCs are the primary containment devices that protect the worker, product, and environment from exposure to microbiological agents. BSC operations, as specified by NSF/ANSI 49-2018, Annex F need to be verified at the time of installation and, as a minimum, annually thereafter. A cabinet should be recertified whenever a HEPA or ULPA filter is replaced, maintenance repairs are made to internal parts, or a cabinet is relocated.

Finally, accurate test results can only be assured when the testing equipment is properly maintained and calibrated. It is appropriate to request the calibration information for the test equipment being used by the certifier.

Table 1. Selection of a Safety Cabinet through Risk Assessment

Biosafety Level	Personnel	Protection Provided	Product	Environmental	BSC Class
BSL-1 to 3	Yes	No		Yes	I
BSL-1 to 3	Yes	Yes		Yes	II (A1, A2, B1, B2)
BSL-4	Yes	Yes		Yes	III; II—when used in suit room with suit

Table 2. Comparison of Biosafety Cabinet Characteristics

BSC Class	Face Velocity	Airflow Pattern	Application: Nonvolatile Toxic Chemicals and Radionuclides	Application: Volatile Toxic Chemicals and Radionuclides
I	75	In at front through HEPA to the outside or into the room through HEPA (Figure 2)	Yes	When exhausted outdoors ^{a,b}
II, A1	75	70% recirculated to the cabinet work area through HEPA; 30% balance can be exhausted through HEPA back into the room or to outside through a canopy unit (Figure 3) ^c	Yes (small amounts) ^b	Yes (small amounts) ^{a,b}
II, B1	100	30% recirculated, 70% exhausted. Exhaust cabinet air must pass through a dedicated, internal cabinet duct to the outside through a HEPA filter (Figures 5a 5b)	Yes	Yes (small amounts) ^{a,b}
I, B2	100	No recirculation; total exhaust to the outside through a HEPA filter (Figure 6)	Yes	Yes (small amounts) ^{a,b}
II, A2	100	Similar to II, A1, but has 100 fpm intake air velocity exhaust air can be ducted to the outside through a canopy unit (Figure 7)	Yes	When exhausted outdoors (formally B3), (small amounts) ^{a,b}
II, C1	100	30% recirculated, 70% exhausted. Exhaust cabinet air must pass through a dedicated, internal cabinet duct to the outside through a blower and HEPA filter	Yes	Yes (small amounts) ^{a,b}
III	N/A	Supply air is HEPA-filtered. Exhaust air passes through two HEPA filters in series and is exhausted to the outside via a hard connection (Figure 8)	Yes	Yes (small amounts) ^{a,b}

- Installation requires a special duct to the outside, and may require an in-line charcoal filter, and/or a spark-proof (explosion-proof) motor and other electrical components in the cabinet. Discharge of a Class I or Class II, Type A2 cabinet into a room should not occur if volatile chemicals are used.
- A risk assessment should be completed by laboratory and safety facility personnel to determine amounts to be used. In all cases, only the smallest amounts of the chemical(s) required for the work to be performed should be used in the BSC. In no instance should the chemical concentration approach the lower explosion limits of the compounds.

- c. Class IIA1 cabinets built prior to 2010 were allowed to have potentially contaminated, positively pressurized plenums. After 2010, All Class II cabinets must have potentially contaminated plenums under negative pressure or surrounded by negatively pressurized plenums.

Figure 1. HEPA Filters

HEPA filters are typically constructed of paper-thin sheets of borosilicate medium, pleated to increase surface area, and affixed to a frame. Aluminum or plastic separators are often added for stability.

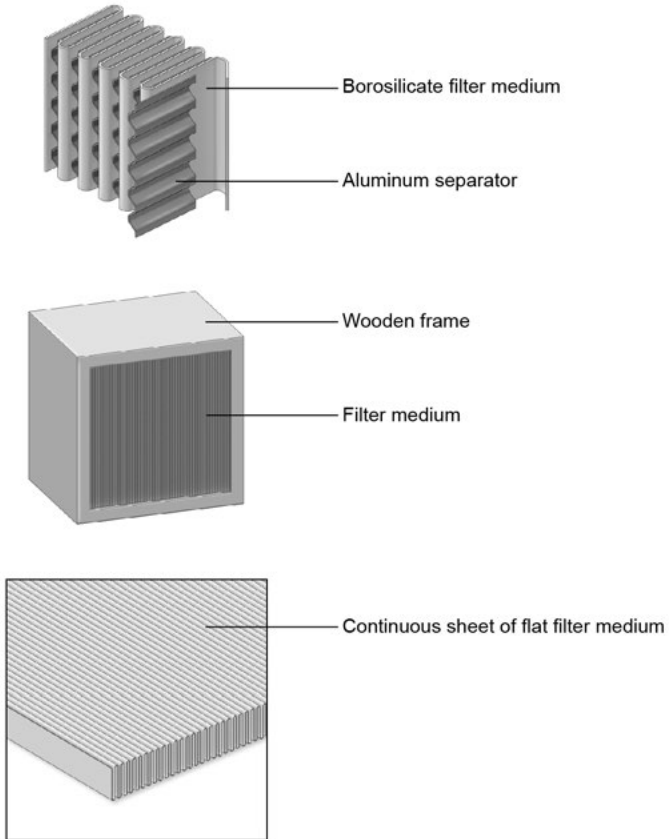

Figure 2. The Class I BSC

(A) front opening; (B) sash; (C) exhaust HEPA filter; (D) exhaust plenum. Note: this classical style cabinet needs to be direct-connected to the building exhaust system.

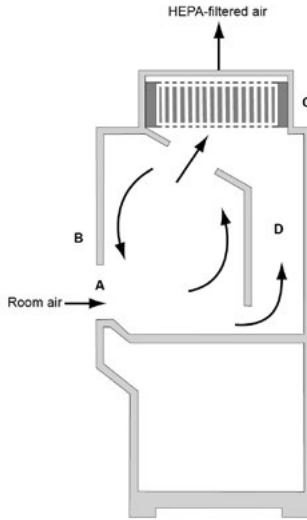

Figure 3. The Class II, Type A BSC

(A) front opening; (B) sash; (C) exhaust HEPA filter; (D) supply HEPA filter; (E) common plenum; (F) exhaust blower. Note: Since 2010 there is minimal difference between the Class II, Type A1 and Class II, Type A2 except for the inflow velocity.

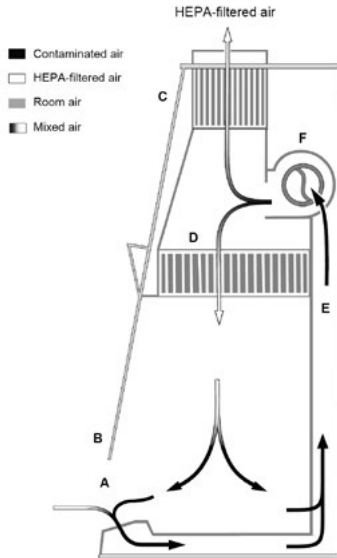

Figure 4. Canopy (thimble) unit for ducting a Class II, Type A BSC

(A) balancing damper; (B) flexible connector to exhaust system; (C) cabinet exhaust HEPA filter housing; (D) canopy unit; (E) BSC. Note: There is a gap between the canopy unit (D) and the exhaust filter housing (C), through which room air is exhausted.

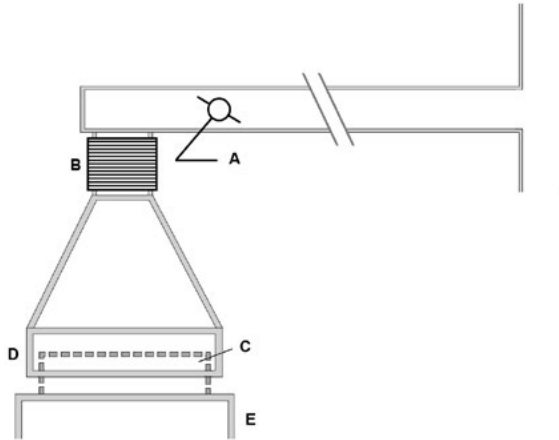

Figure 5a. The Class II, Type B1 BSC (classic design)

(A) front opening; (B) sash; (C) exhaust HEPA filter; (D) supply HEPA filter; (E) negative pressure dedicated exhaust plenum; (F) blower; (G) additional HEPA filter for supply air. Note: The cabinet exhaust needs to be direct-connected to the building exhaust system.

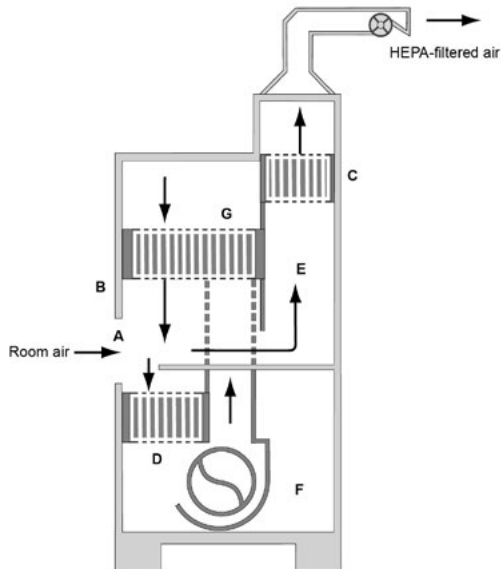

Figure 5b. The Class II, Type B1 BSC (benchtop design)

(A) front opening; (B) sash; (C) exhaust HEPA filter; (D) supply plenum; (E) supply HEPA filter; (F) blower; (G) negative pressure exhaust plenum. Note: The cabinet exhaust needs to be direct-connected to the building exhaust system.

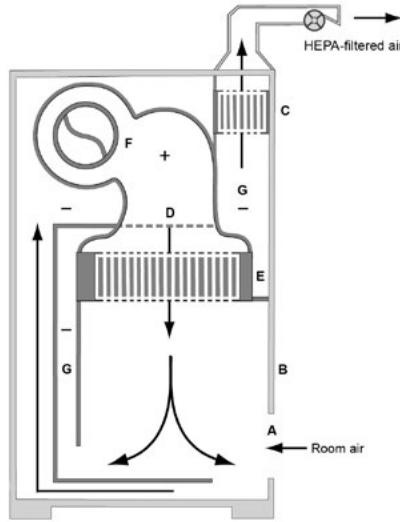

Figure 6. The Class II, Type B2 BSC

(A) front opening; (B) sash; (C) exhaust HEPA filter; (D) supply HEPA filter; (E) negative pressure exhaust plenum. Note: The cabinet needs to be direct-connected to the building exhaust system.

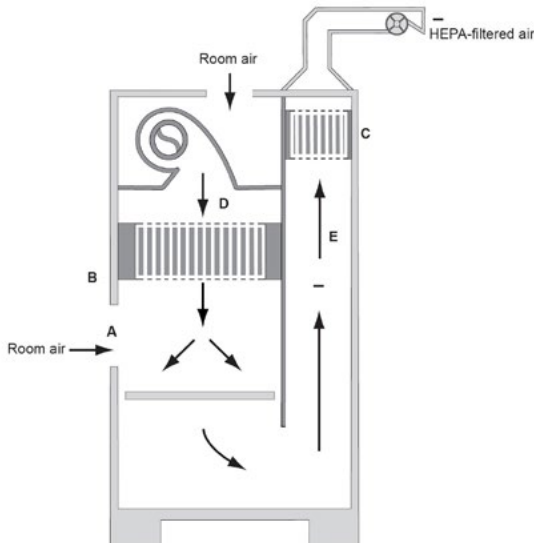

Figure 7a. The Class II, Type C1 BSC (not connected to building exhaust system)

(A) front opening; (B) sash; (C) exhaust HEPA filter; (D) supply filter; (E) supply blower; (F) exhaust blower.

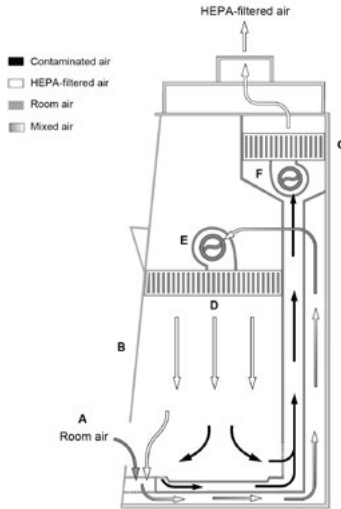

Figure 7b. The Class II, Type C1 BSC (connected to building exhaust system)

(A) front opening; (B) sash; (C) exhaust HEPA filter; (D) supply HEPA filter; (E) supply blower; (F) exhaust blower; (G) balancing damper; (H) sealed flexible duct (optional); (I) canopy opening/gap; (J) exhaust duct.

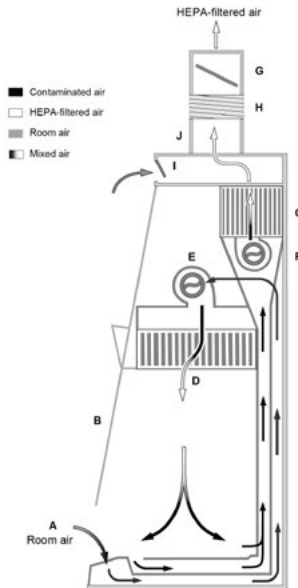

Figure 8. The Class III BSC

(A) glove ports with O-ring for attaching arm-length gloves to cabinet; (B) window; (C) exhaust HEPA filter; (D) supply HEPA filter; (E) double-ended autoclave or pass-through box; (F) exhaust HEPA filter. Note: A chemical dunk tank may be installed, which would be located beneath the work surface of the BSC with access from above. The cabinet exhaust needs to be direct-connected to an exhaust system where the fan is separate from the exhaust fans of the facility ventilation system. The exhaust air must be double HEPA-filtered or HEPA-filtered and incinerated.

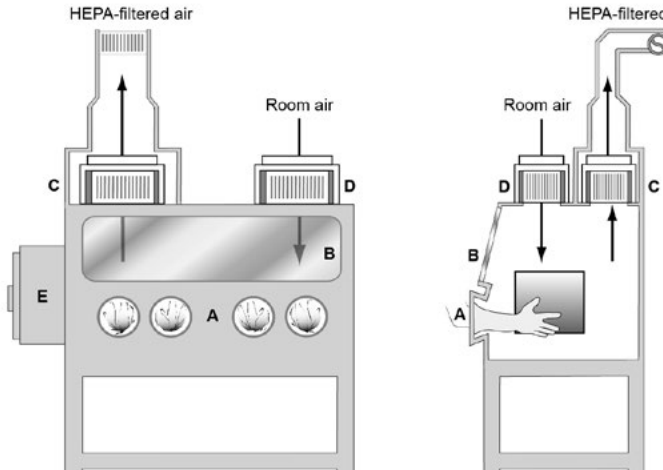

Figure 9a. The Horizontal Laminar flow Clean Bench

(A) front opening; (B) supply grille; (C) supply HEPA filter; (D) supply plenum; (E) blower.

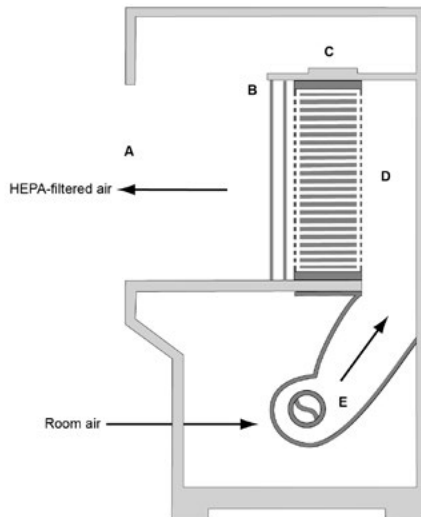

Figure 9b. The Vertical Laminar Flow Clean Bench

(A) front opening; (B) sash; (C) supply HEPA filter; (D) blower. Note: Some vertical flow clean benches have recirculated air through front and/or rear grilles.

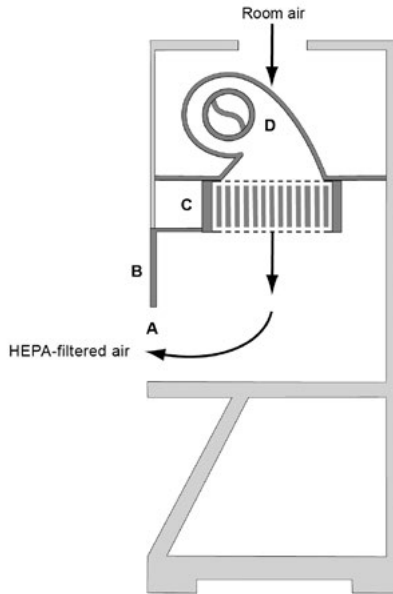

Figure 10. Clean to Dirty

A typical layout for working from the clean to the dirty side within a Class II BSC. Clean cultures (left) can be inoculated (center); contaminated pipettes can be discarded in the shallow pan and other contaminated materials can be placed in the biohazard bag (right). This arrangement is reversed for left-handed persons.

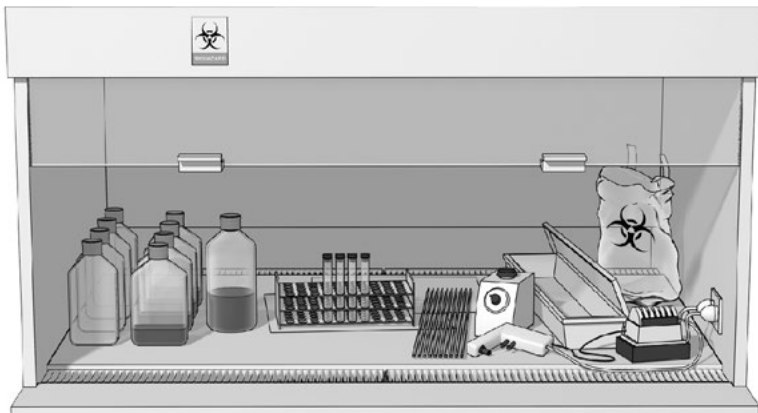

Figure 11. Protection of a house vacuum

Example method to protect a house vacuum system during aspiration of infectious fluids. The suction flask (A) is used to collect the contaminated fluids into a suitable decontamination solution; the right flask (B) serves as a fluid overflow collection vessel. An in-line HEPA filter (C) is used to protect the vacuum system (D) from aerosolized microorganisms.

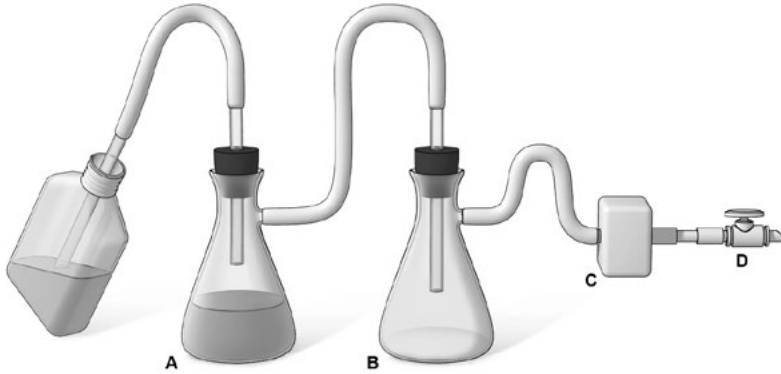
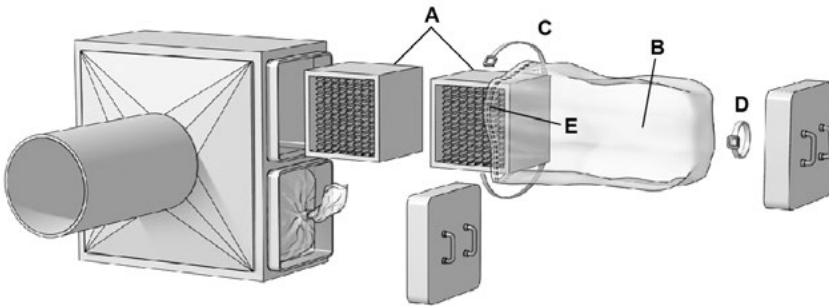

Figure 12. Bag-in/bag-out filter enclosure

A bag-in/bag-out filter enclosure allows for the removal of the contaminated filter without worker exposure. (A) filters; (B) bags; (C) safety straps; (D) cinching straps; (E) shock cord located in the mouth of the PVC bag restricts the bag around the second rib of the housing lip.



Acknowledgments

We gratefully acknowledge the Baker Company; Filtration Group, Inc.; Flanders Filters; and Forma Scientific, Inc., for use of some drawings and figures reproduced herein.

References

1. Kruse RH, Puckett WH, Richardson JH. Biological safety cabinetry. *Clin Microbiol Rev.* 1991;4(2):207–41.
2. HEPA and ULPA Filters, IEST-RP-CC001 (2016).
3. First MW. Filters, high capacity filters and high-efficiency filters: review and production. In: *Place Filter Testing Workshop*; 1971; Boston, Massachusetts.
4. Dow Chemical U.S.A.; National Cancer Institute. *A Workshop for Certification of Biological Safety Cabinets*. No. BH 74-01-11. Midland (MI): Dow Chemical U.S.A.; 1974.
5. Richmond JY. Safe practices and procedures for working with human specimens in biomedical research laboratories. *J Clin Immunoassay.* 1988;13:115–9.
6. Barbeito MS, Taylor LA. Containment of microbial aerosols in a microbiological safety cabinet. *Appl Microbiol.* 1968;16(8):1255–9.
7. Whitfield WJ. *A new approach to cleanroom design*. Albuquerque (NM): Sandia Corporation; 1962.
8. NSF International (NSF); American National Standards Institute (ANSI). *NSF/ANSI 49-2018. Biosafety Cabinetry: Design, Construction, Performance, and Field Certification*. Ann Arbor (MI): NSF/ANSI; 2018.
9. Jones RL Jr, Tepper B, Greenier TG, Stuart DG, Large S, Eagleson D. Effects of Thimble Connections of Biological Safety Cabinets. *Abstracts of 32nd Biological Safety Conference*; 1989; New Orleans, LA.
10. *Guidelines for Cytotoxic (Antineoplastic) Drugs*. Standard 01-23-001, Appendix A (1986).
11. Centers for Disease Control and Prevention; National Institute for Occupational Safety and Health. *NIOSH Alert: Preventing Occupational Exposures to Antineoplastic and Other Hazardous Drugs in Health Care Settings*. Cincinnati (OH): NIOSH—Publications Dissemination; 2004.
12. Stuart DG, First MW, Jones RL Jr, Eagleson JM Jr. Comparison of chemical vapor handling by three types of class II biological safety cabinets. *Particulate and Microbial Control*. 1983.
13. Stuart D, Kiley M, Ghidoni D, Zarembo M. The Class III Biological Safety Cabinet. In: Richmond JY, editor. *Anthology of Biosafety VII: Biosafety Level 3*. Mundelein (IL): American Biological Safety Association; 2004. p. 57–71.
14. American Conference of Governmental Industrial Hygienists (ACGIH). *Threshold limit values for chemical substances and physical agents and biological exposure indices*. Cincinnati (OH): ACGIH; 2006.

15. National Institutes of Health. NIH guidelines for the laboratory use of chemical carcinogens. Washington (DC): U.S. Department of Health & Human Services; 1981.
16. National Cancer Institute; Office of Research Safety. Laboratory safety monograph: a supplement to the NIH guidelines for recombinant DNA research. Bethesda (MD): National Institutes of Health; 1978.
17. Office of Research Safety; National Cancer Institute. National Cancer Institute Safety Standards for Research Involving Chemical Carcinogens. Bethesda (MD): The National Institutes of Health; 1975.
18. Jones R, Drake J, Eagleson D. Using Hydrogen Peroxide Vapor to Decontaminate Biological Safety Cabinets. Baker [Internet]. 1993 [cited 2019 Mar 11];1(1):[about 4 p.] Available from: <https://bakerco.com/communication/white-papers/>
19. Jones R, Stuart D, Large S, Ghidoni D. Cycle Parameters for Decontaminating a Biological Safety Cabinet Using H₂O₂ Vapor. Baker [Internet]. 1993 [cited 2019 Mar 11];1(2):[about 4 p.] Available from: <https://bakerco.com/communication/white-papers/>
20. Jones R, Stuart D, PhD, Large S, Ghidoni D. Decontamination of a HEPA filter using hydrogen peroxide vapor. *Acumen*. 1993;1(3):1–4.
21. Fox D, editor. Proceedings of the National Cancer Institute symposium on design of biomedical research facilities. Monograph Series. Vol 4; 1979 Oct 18–19; Frederick, MD. Litton Bionetics, Inc.; 1979.
22. Laboratories. In: American Society of Heating, Refrigerating and Air-Conditioning Engineers. 2015 ASHRAE Handbook—HVAC Applications. Atlanta (GA): ASHRAE; 2015.
23. Agricultural Research Service (ARS) [Internet]. Beltsville (MD): United States Department of Agriculture; c2012 [cited 2019 Mar 12]. ARS Facilities Design Standards. ARS—242.1. Available from: <https://www.afm.ars.usda.gov/ppweb/pdf/242-01m.pdf>
24. American Conference of Governmental Industrial Hygienists (ACGIH). Industrial Ventilation: A Manual of Recommended Practice for Design. 28th ed. Cincinnati (OH): ACGIH; 2015.
25. Jones RL Jr, Stuart DG, Eagleson D, Greenier TJ, Eagleson JM Jr. The effects of changing intake and supply air flow on biological safety cabinet performance. *Appl Occup Environ Hyg*. 1990;5(6):370–7.
26. Jones RL Jr, Stuart DG, Eagleson, D, et al. Effects of ceiling height on determining calculated intake air velocities for biological safety cabinets. *Appl Occup Environ Hyg*. 1991;6(8):683–8.

27. Rake BW. Influence of crossdrafts on the performance of a biological safety cabinet. *Appl Environ Microbiol.* 1978;36(2):278–83.
28. Barbeito MS, West DL, editors. Laboratory ventilation for hazard control. *Proceedings of a 1976 Cancer Research Safety Symposium*; 1976 Oct 21–22; Frederick, MD. Frederick (MD): Frederick Cancer Research Center; 1976.
29. Airborne Particulate Cleanliness Classes in Clean rooms and Clean Zones, Federal Standard No. 209 (1963).
30. Cleanrooms and associated controlled environments—Part 1: Classification of air cleanliness by particle concentration, ISO 14644-1 (2015).
31. National Cancer Institute. Specifications for general purpose clean air biological safety cabinet. Bethesda (MD): National Institutes of Health; 1973.